

POWER RATING

Production tolerance : ± 3%

MODEL	CONDITIONS	POWER	rpm	Base Engine
L066TIH	HEAVY DUTY	180PS (132kW)	2,200	DB58TI

Note : 1) No reduction in rating for intake air temperature is up to 45 °C (318K) and sea water temperature is up to 32 °C (305K) , relative humidity is up to 60 % all data are based on operation to ISO 3046.

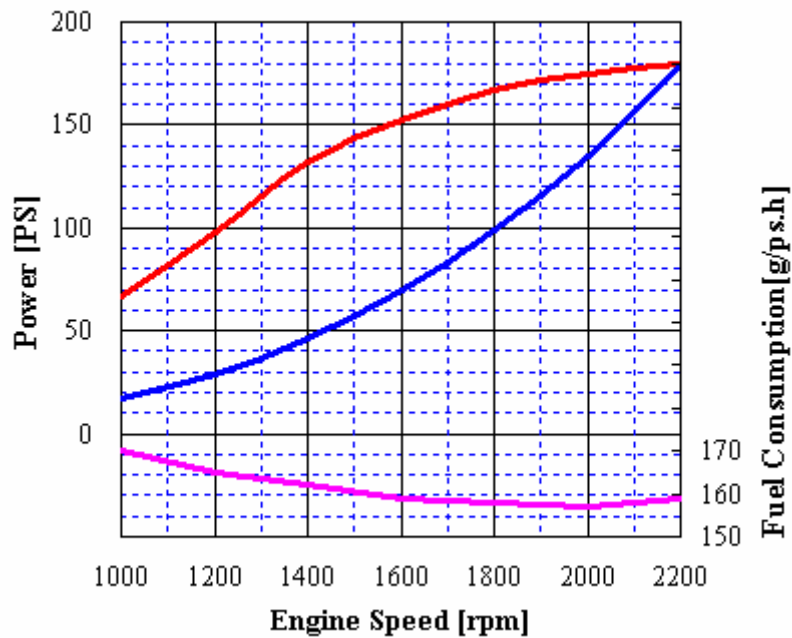
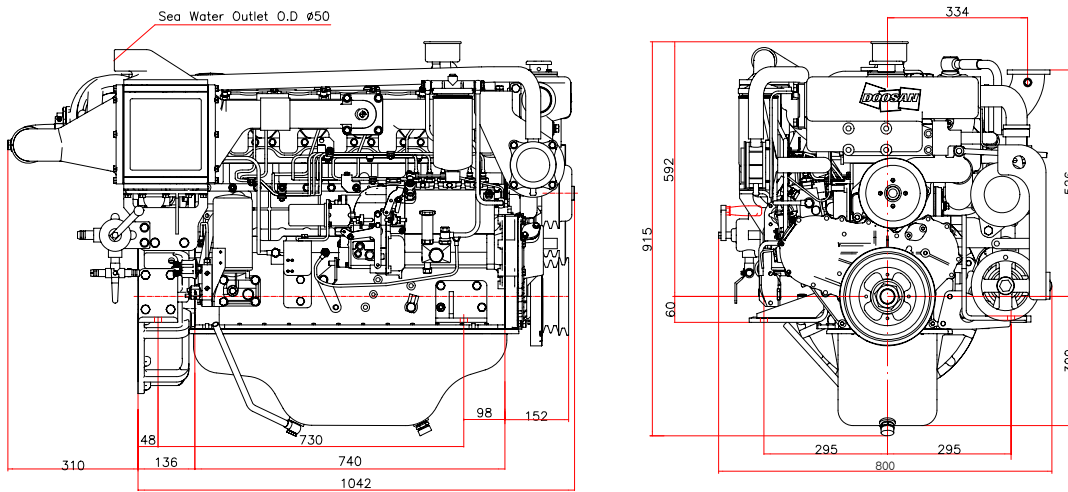

- **Heavy Duty** : Operation hours are unlimited per year, at average load is up to 90 % , At full load is up to 80 %
Typical gearbox ratio: 2.5 ~ 6
(Fishing trawler, Pushing vessel, Cargo boat, Ferry)

Engine Specification

Model		Units	L066TIH
Engine type			4 cycle, In line, direct- injection, water cooled with turbo charger & inter-cooler
Rating output (B.H.P)		PS(kW)/rpm	180(132)/2,200
Displacement		cc	5,785
Cylinder number - bore(φ) x stroke		mm	6 - φ102 x 118
Valve clearance at cold	In / Ex	mm	0.4 / 0.4
Low idling rpm		rpm	750 ± 25
No load max. rpm		rpm	below 2,420
Mean effective pressure		kg/cm ²	12.73
Mean piston speed		m/sec.	7.87
Compression ratio			19.5 : 1
Firing order			1 - 5 - 3 - 6 - 2 - 4
Compression pressure	at 200 rpm	kg/cm ²	above 30 (Initial condition)
Governor type of injection pump			Mechanical all speed (R.S.V)
Fuel consumption		g/PS.h	159
		lit / h	34.5
Injection timing (B.T.D.C)		deg	15° ± 1°
Fuel inj.nozzle opening pressure		kg/cm ²	200
Starting system			Electric Starting by starter motor
Starter motor capacity		V- kW	24 - 4.5
Alternator capacity		V- A	24 - 45
Battery		V- Ah	24 - 100
Cooling system			Indirect sea water cooling with heat exchanger
Cooling water capacity	Max. / Min.	lit	25 / 20
Fresh water pump type			Centrifugal type, driven by V- belt
Sea water pump type			Rubber impeller type driven by V- belt
Lubricating oil (Engine)	pan capacity	lit	Max : 19 , Min : 14 (Engine total : 21)
	pressure	kg/cm ²	Full : 3.5, Idle : 1.0
Marine gear	Model		DMT70TF (Dong-I)
	Gear ratio		1.61 2.06 2.45 2.82 3.12 3.46
Direction of revolution	crankshaft		Counter clockwise viewed from stern side
	propeller		Clockwise viewed from stern side
Engine size (L x W x H)	without R/G	mm	1,042 x 800 x 915
	with R. gear	kg	1,397 x 800 x 915
Engine dry weight	without R/G	kg	535
	with R. gear	kg	717

psi = kg/cm² x 14.22
 lb/ft. = N.m x 0.737
 kW = 0.2388 kcal/s

lb = kg x 2.205
 lb/PS.h = g/kW.h x 0.00162
 cfm = m³/min x 35.3

hp = PS x 0.98635
 U.S gal. = liter x 0.264

Head office
 7-11, Hwasu-Dong, Dong-Gu, Incheon, Korea
TEL : 82-32-760-1951, 1953 FAX : 82-32-761-2759
Seoul Office
 Doosan Infracore Co. Ltd.,
 22nd Floor, Doosan Tower, 18-12, Euljiro 6-ga, Jung-gu,
 Seoul, Korea.
TEL : 82-2-3398-8521-8536 FAX : 82-2-3398-8509
Web site : www.doosaninfracore.com

※ Specifications are subject to change without prior notice.